

TOUCH PANEL CONTROLLED THERMOSTATIC RECESSED CEILING MOUNT MATTE BLACK LED MUSICAL RAINFALL SHOWER SYSTEM WITH BODY JET SPRAYS AND HAND SHOWER SPECIFICATIONS

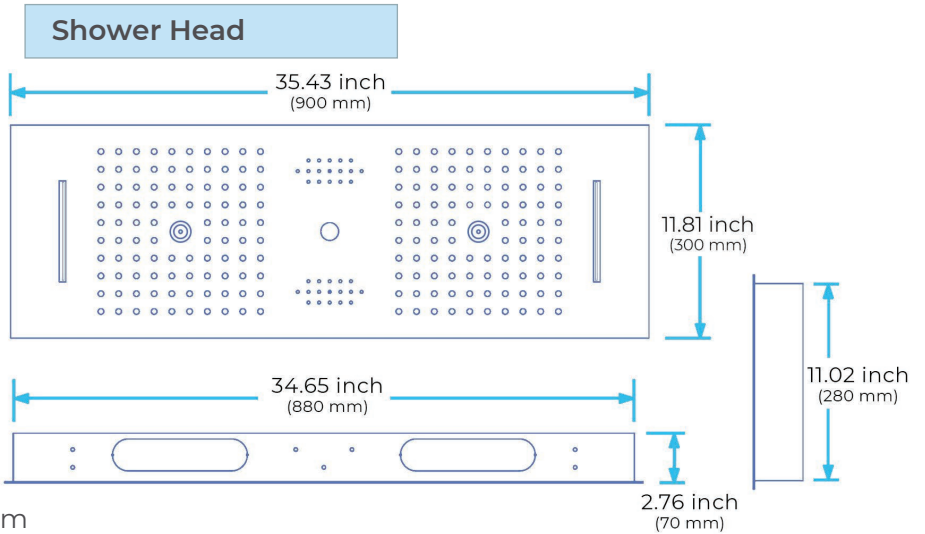

- Product Type : Complete Shower System
- Shower Head Type : Fixed shower head
- Finish : Brushed Gold
- Primary Material : Brass
- Leak Resistant : Yes
- Maximum Flow Rate (GPM) : 7.8
- Adjustable Water Flow : Yes
- Hand Shower Included : Yes
- Rough-in Valve Included : Yes
- Diverter Valve Included : Yes
- Pipe Thread Type : NPT / IPS 1/2 Outlet - 3/4 inlet
- Diverter Type : Three-Valve Diverter
- Wall Supply Elbow Included : Yes
- Spray Pattern : Rain / Waterfall/ Mist Spray/ Column/Body Jets
- Faucet Control Type : Thermostatic
- Electronic Control Unit Included : Yes
- Handle(s) Included : Yes
- Flange/Escutcheon Included : Yes
- Mounting Location : Ceiling Mounted
- Shower Head Included : Yes
- Overall Product Weight : 60lbs
- Installation Required : Yes
- Handle Style : Knob
- Shower Head Height - Top to Bottom : 2.7"
- Shower Head Width - Side to Side : 35.5"
- Trim Width - Side to Side : 5.11"
- Required Valve Type : Thermostatic
- Commercial Warranty : Yes
- Supplier Intended and Approved Use : Non Residential Use;Residential Use
- Diverter Required : Yes
- Valve Cartridge Included : Yes
- Body Spray Height - Top to Bottom : 5"
- Number of Body Jets : 6
- Showerhead Plating Material : Stainless Steel
- Number of Handles : 6

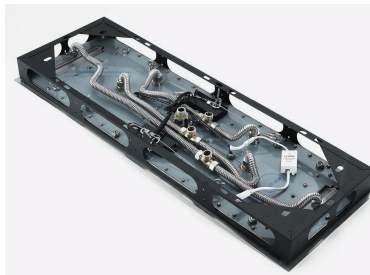

Product shown is only for installation display purpose

Touch Panel Control

- Turn On/Off Control
- MANUAL MODE Total 64 colors
- M Auto mode setting
- M AUTO MODE Total 11 Auto mode
- Set the speed of color change, fast/slow

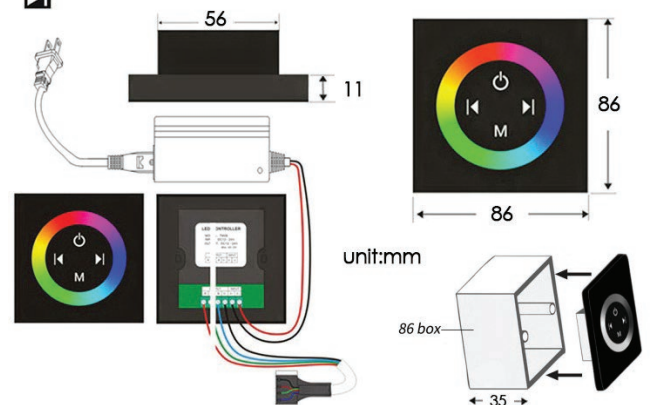

All dimensions and specifications are nominal and may vary. Use actual products for accuracy in critical situations.

Shower Mixer

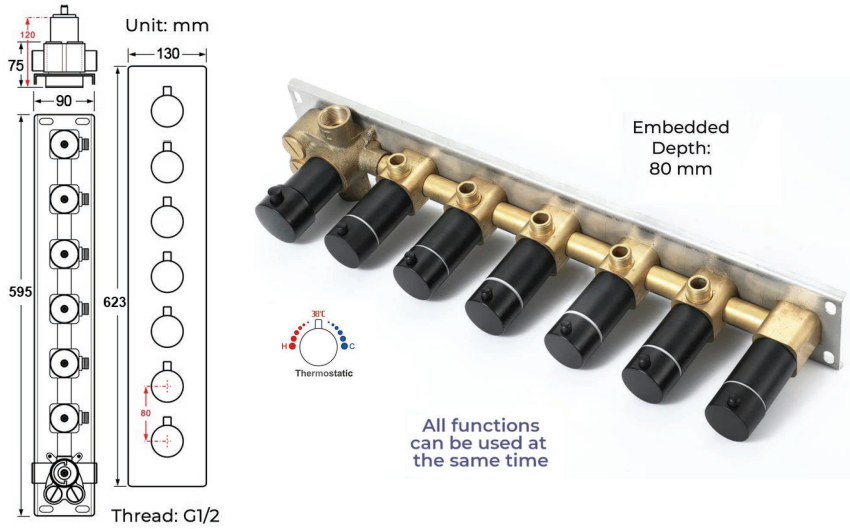

Product shown is only for installation display purpose

Hand Shower

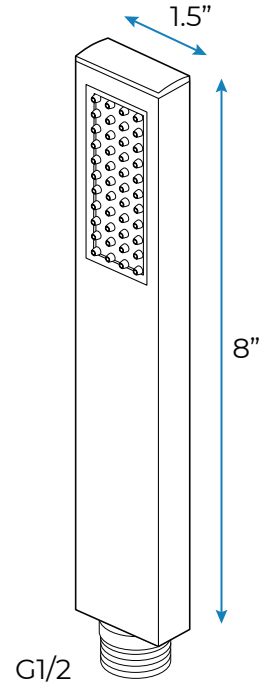

Flow Rate: 2.0 GPM / 7.6 LPM

Shower Mixer Connections

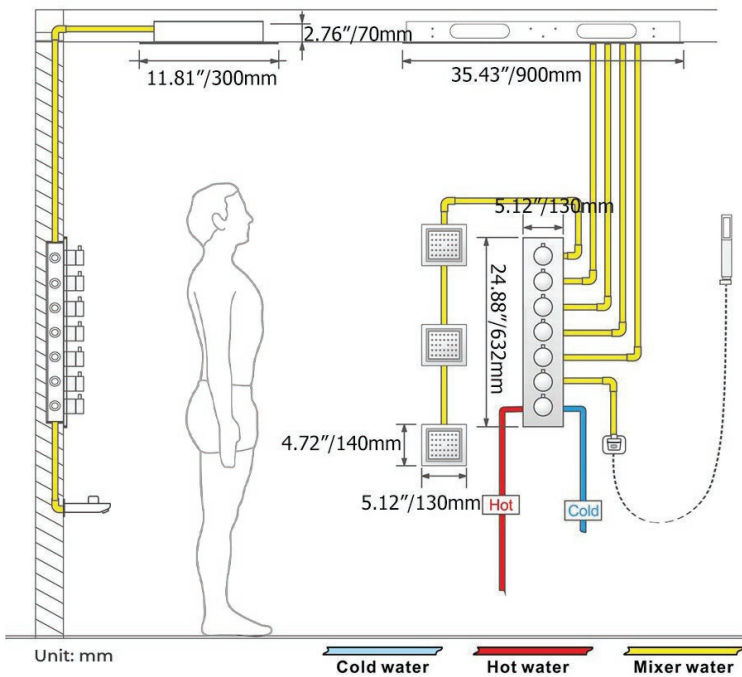

Spout

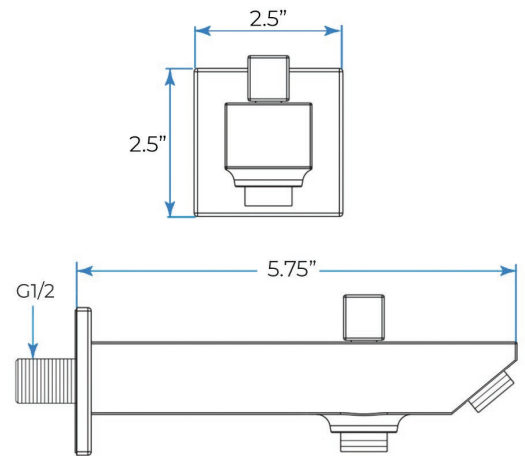

Body Jet

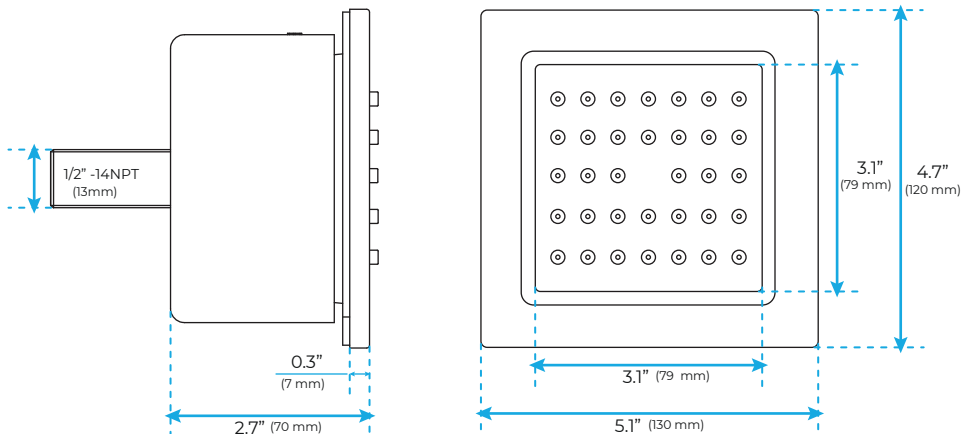

FEATURES

- Material: Brass
- Base Plate Height: 5-1/8"
- Base Plate Width: 5-1/8"
- Jet Surface Area: 3-1/8"
- Surface Depth: 1/4"
- Adjustment Angle: 5°
- Male NPT Connection: 1/2"
- Maximum Flow Rate: 2.5 GPM (9.5L/min) max @ 80 psi